







Bianca Shower Mixer With Diverter

Finish & SKU

 Chrome NR321511aCH	 Brushed Nickel NR321511aBN
 Matte Black NR321511aMB	 Brushed Gold NR321511aBG
 Brushed Bronze NR321511aBZ	 Gun Metal NR321511aGM

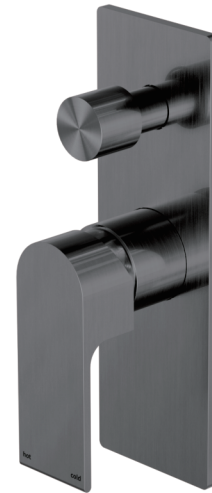

Specifications

Watermark License

WM-060073

Temperature Rating

Min 1°C-Max 75°C

Pressure Rating

Min 150kpa-Max 500kpa

Warranty



Lead Free

Features

- 35mm ceramic cartridge can be adjusted to control water temperature and flow control setting, saving energy
- Shower mixer with quarter turn Diverter defaults to bath spout/shower
- Metal wall plate construction for longevity
- Body inlets – ½ BSP female
- Suitable for mains pressure installation
- Wels rating not required
- Replaceable trim kits
- Packed Separately (Body and Trim Kits)

Maintenance And Care

- Regularly check the mixer and connections for signs of wear or leaks.
- Clean the tap with mild soapy water to maintain its appearance, avoiding harsh chemicals and abrasive materials that may damage the finish.

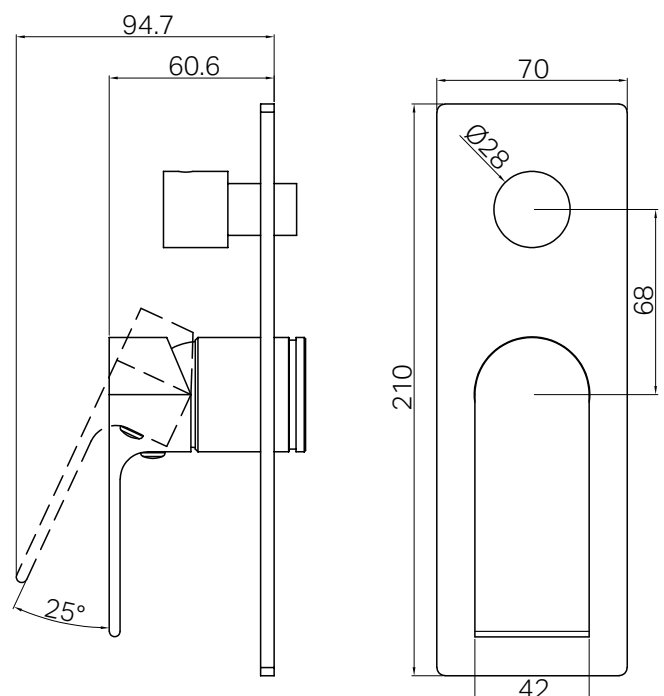

- Dimensions are nominal measurements only.