







Bianca Shower Mixer

Finish & SKU

 Chrome NR321511CH	 Brushed Nickel NR321511BN
 Matte Black NR321511MB	 Brushed Gold NR321511BG
 Brushed Bronze NR321511BZ	 Gun Metal NR321511GM



Specifications

Watermark License

WM-060073

Temperature Rating

Min 1°C-Max 75°C

Pressure Rating

Min 150kpa-Max 500kpa

Warranty



Lead Free

Features

- 35mm ceramic cartridge can be adjusted to control water temperature and flow control setting, saving energy
- Metal wall plate construction for longevity
- Body inlets – ½ BSP female
- Suitable for mains pressure installation
- Wels rating not required
- Replaceable trim kits
- Packed Separately (Body and Trim Kits)

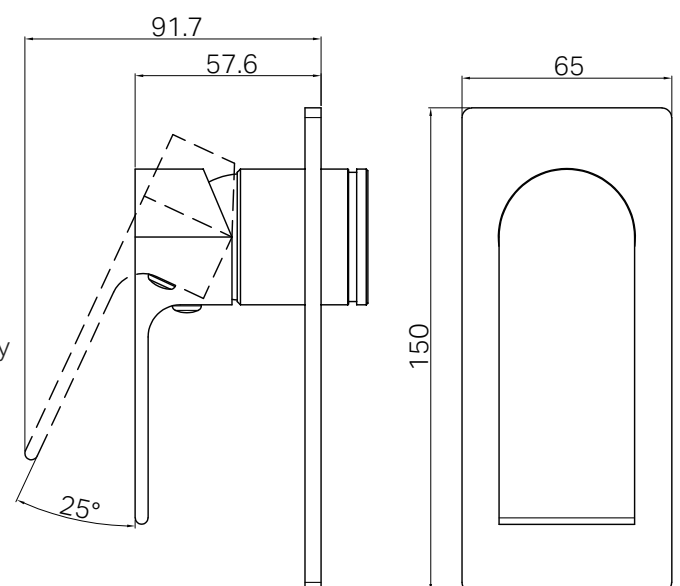

Maintenance And Care

- Regularly check the mixer and connections for signs of wear or leaks.
- Clean the tap with mild soapy water to maintain its appearance, avoiding harsh chemicals and abrasive materials that may damage the finish.

- Dimensions are nominal measurements only.